

POWERTEC

PORTABLE POWER SOLUTIONS

PT6600ES PORTABLE GENERATOR

7000W



INSTRUCTION MANUAL

Contents

Introduction.....	3
Environmental protection.....	3
Scope of product.....	3
Description of symbols.....	3
Specifications.....	3
Safety instructions for power tools.....	4
Know your product.....	8
Unpacking.....	8
Approximate wattage requirements.....	9
Preparing the generator.....	10
Checking the engine fuel.....	10
Checking the engine oil.....	10
Connecting the battery.....	11
Starting the engine with keystack.....	11
Starting the engine manually	12
Stopping the engine.....	12
Connecting apparatus to the generator.....	12
AC safety switch.....	13
Safety switch tripping.....	13
Generator maintenance.....	14
Storage.....	14
Spark plugs.....	15
Engine oil replacement.....	15
Air filter.....	15
Petrol tank filter.....	16
Tap extension fuel filter.....	16
Repairs.....	17
Cleaning.....	17
Troubleshooting.....	17
Warranty.....	18

Introduction

Your new POWERTEC Generator will more than satisfy your expectations. It has been manufactured under stringent quality standards to meet superior performance criteria. You will find your new tool easy and safe to operate, and, with proper care, it will give you many years of dependable service.

CAUTION:

Carefully read through this entire Instruction Manual before using your new POWERTEC Generator. Take special care to heed the Cautions and Warnings.

Your generator has many features that will make your job faster and easier. Safety, performance, and dependability have been given top priority in the development of this tool, making it easy to maintain and operate.

Environmental Protection

Recycle unwanted materials instead of disposing of them as waste. All tools, hoses and packaging should be sorted, taken to the local recycling centre and disposed of in an environmentally safe way.



Scope Of Product

This product is suited for home, camping, emergency power and periodic duty commercial use applications. It will operate most powertools, appliances and lighting.

Description Of Symbols

The rating plate on your tool may show symbols. These represent important information about the product or instructions on its use.



Wear hearing protection.
Wear eye protection.
Wear breathing protection.



5405

Conforms to relevant standards for electromagnetic compatibility.

Specifications

AC Output:	230V AC ~ 50Hz
Rated Power:	6500W
Peak Power:	7000W
Phase:	Single
Power Factor:	COS ϕ = 1
Displacement:	420cc
Engine:	14HP, 4 stroke
No Load Speed:	3000 RPM
Fuel Tank Capacity:	25L
Fuel Type:	Unleaded petrol
Engine Oil Type:	SAE30
Operation Noise Level:	68dBA / 7m
Net Weight:	95kg

Safety Instructions for Power Tools

To use this tool properly, you must observe the safety regulations, the assembly instructions and the operating instructions to be found in this Manual. All persons who use and service the machine have to be acquainted with this Manual and must be informed about its potential hazards. Children and infirm people must not use this tool. Children should be supervised at all times if they are in the area in which the tool is being used. It is also imperative that you observe the accident prevention regulations in force in your area. The same applies for general rules of occupational health and safety.

WARNING:

When using power tools, basic safety precautions should always be taken to reduce the risk of fire, electric shock and personal injury. Also, please read and heed the advice given in the additional important safety instructions.

- 1. Keep the work area clean and tidy.** Cluttered work areas and benches invite accidents and injury.
- 2. Consider the environment in which you are working.** Do not use power tools in damp or wet locations. Keep the work area well lit. Do not expose power tools to rain. Do not use power tools in the presence of flammable liquids or gases.
- 3. Keep visitors away from the work area.** All visitors and onlookers, especially children and infirm persons, should be kept well away from where you are working. Do not let others in the vicinity make contact with the tool or extension cord.
- 4. Store tools safely.** When not in use, tools should be locked up out of reach.
- 5. Do not force the tool.** The tool will do the job better and safer working at the rate for which it was designed.
- 6. Use the correct tool for the job.** Do not force small tools or attachments to do the job best handled by a heavier duty tool. Never use a tool for a purpose for which it was not intended.

7. Dress correctly. Do not wear loose clothing or jewellery. They can be caught in moving parts. Rubber gloves and non-slip footwear are recommended when working outdoors. If you have long hair, wear a protective hair covering.

8. Use safety accessories. Safety glasses and earmuffs should always be worn. A face or dust mask is also required if the drilling operation creates dust.

9. Secure the work piece. Use clamps or a vice to hold the work piece. It is safer than using your hand and frees both hands to operate the tool.

10. Do not overreach. Keep your footing secure and balanced at all times.

11. Look after your tools. Keep tools sharp and clean for better and safer performance. Follow the instructions regarding lubrication and accessory changes. Inspect tool cords periodically and, if damaged, have them repaired by an authorised service facility. Inspect extension cords periodically and replace them if damaged. Keep tool handles dry, clean and free from oil and grease.

12. Remove adjusting keys and wrenches. Check to see that keys and adjusting wrenches are removed from the tool before switching on.

13. Stay alert. Watch what you are doing. Use common sense. Do not operate a tool when you are tired.

14. Check for damaged parts. Before using a tool, check that there are no damaged parts. If a part is slightly damaged, carefully determine if it will operate properly and perform its intended function. Check for alignment of moving parts, binding of moving parts, breakage of parts, proper mounting and any other conditions that may affect the operation of the tool. A part that is damaged should be properly repaired or replaced by an authorised service facility, unless otherwise indicated in this Instruction Manual.

15. Use only approved parts. When servicing, use only identical replacement parts. Use an authorised service facility to fit replacement parts.

WARNING:

The use of an accessory or attachment, other than those recommended in this Instruction Manual, may present a risk of personal injury.

Save these important safety instructions

Risk of electrocution and fire		
Hazard	What could happen	How to prevent it
Improper storage of extension cord.	Extension cord can come into contact with hot engine parts resulting in damage. Using a damaged extension cord can result in electrocution or death.	Remove extension cord from the generator and store separately away from generator.
Operation of generator in rain, wet, icy, or flooded conditions.	Water is an excellent conductor of electricity! Water which comes in contact with electrically charged components can transmit electricity to the frame and other surfaces, resulting in electrical shock to anyone contacting them.	Operate generator in a clean, dry, well ventilated area. Make sure hands are dry before touching unit.
Placing generator on or against highly conductive surface, such as a steel walkway or metal roof.	Accidental leakage of electrical current could charge conductive surfaces in contact with the generator.	Place generator on low conductivity surface such as a concrete slab. ALWAYS operate generator a minimum of 2 meters from any conductive surface.
Use of worn, damaged or ungrounded extension cords.	Contact with worn or damaged extension cords could result in electrocution. Use of ungrounded cordsets could prevent operation of circuit breakers and result in electrical shock.	Inspect extension cords before use and replace with new cord if required. Always use a cordset having a grounding wire with an appropriate grounding plug. DO NOT use an ungrounded plug.
Operation of unit when damaged, or with guards or panels removed.	Attempting to use the unit when it has been damaged, or when it is not functioning normally could result in fire or electrocution. Removal of guarding could expose electrically charged components and result in electrocution.	Do not operate generator with mechanical or electrical problem. Have unit repaired by an Authorized Service Centre. Do not operate generator with protective guarding removed.

Risk of fire		
Hazard	What could happen	How to prevent it
Attempting to fill the fuel tank while the engine is running.	Fuel and fuel vapours can become ignited by coming in contact with hot components such as the muffler, engine exhaust gases, or from an electrical spark.	Turn engine off and allow it to cool before adding fuel to the tank. Equip area of operation with a fire extinguisher certified to handle gasoline or fuel fires.
Sparks, fire, hot objects	Cigarettes, sparks, fires, or other hot objects can cause fuel or fuel vapours to ignite.	Add fuel to tank in well ventilated area. Make sure there are no sources of ignition near the generator.
Improper storage of fuel	Improperly stored fuel could lead to accidental ignition. Fuel improperly secured could get into the hands of children or other unqualified persons.	Store fuel in an approved container designed to hold fuel. Store container in secure location to prevent use by others.
Tampering with factory set engine speed settings.	Engine speed has been factory set to provide safe operation. Tampering with the engine speed adjustment could result in overheating of attachments and could cause a fire.	Never attempt to "speed-up" the engine to obtain more performance. Both the output voltage and frequency will be thrown out of standard by this practice, endangering attachments and the user.
Inadequate ventilation for generator	Materials placed against or near the generator or operating the generator in areas where the temperature exceeds 40° C ambient (such as storage rooms or garages) can interfere with its proper ventilation features causing overheating and possible ignition of the materials or buildings.	Operate generator in a clean, dry, well ventilated area. DO NOT OPERATE UNIT INDOORS OR IN ANY CONFINED AREA.

Overfilling the fuel tank – fuel spillage.	Spilled fuel and its vapours can become ignited from hot surfaces or sparks.	Use care in filling the tank to avoid spilling fuel. Make sure fuel cap is secured tightly and check engine for fuel leaks before starting engine. Move generator away from refuelling area or any spillage before starting engine. Allow for fuel expansion. Never refuel with the engine running.
---	--	---

Risk of injury and property damage when transporting generator

Hazard	What could happen	How to prevent it
Fire, Inhalation, Damage to Vehicle Surfaces	Fuel or oil can leak or spill and could result in fire or breathing hazard, serious injury or death can result. Fuel or oil leaks can damage carpet, paint or other surfaces in vehicles or trailers.	The generator is equipped with a fuel tap, turn the lever of this valve to the off position before transporting to avoid fuel leaks. Transport fuel only in an approved fuel container. Always place generator on a protective mat when transporting to protect against damage to vehicle from leaks. Remove generator from vehicle immediately upon arrival at your destination.

Risk of breathing - inhalation hazard

Hazard	What could happen	How to prevent it
Gasoline engines produce toxic carbon monoxide exhaust fumes.	Breathing exhaust fumes will cause serious injury or death.	Operate generator in clean, dry, well ventilated area. Never operate unit in enclosed areas such as garages, basements, storage, sheds, or in any location occupied by humans or animals. Keep children, pets and others away from area of operating unit.

Risk of unsafe operation

Hazard	What could happen	How to prevent it
Operation of generator in careless manner.	All sources of energy include the potential for injury. Unsafe operation or maintenance of your generator could lead to serious injury or death to you or others.	<ul style="list-style-type: none"> • Review and understand all of the operating instructions and warnings in this manual. • Become familiar with the operation and controls of the generator. Know how to shut it off quickly. • Equip area of operation with a fire extinguisher certified to handle gasoline or fuel fires. • Keep children or others away from the generator at all times.
Operating generator while suspended	Generator will not operate properly and will cause damage to the generator and could cause serious injury or death to you or others.	Never operate generator while suspended or in an unlevel position. Always operate generate on a flat, level surface.

Risk of hot surfaces		
Hazard	What could happen	How to prevent it
Contact with hot engine and generator components.	Contact with hot surfaces, such as engines exhaust components, could result in serious burns.	During operation, touch only the control surfaces of the generator. Keep children away from the generator at all times. They may not be able to recognize the hazards of this product.

Risk of moving parts		
Hazard	What could happen	How to prevent it
Contact with moving parts can result in serious injury.	The generator contains parts which rotate at high speed during operation. These parts are covered by guarding to prevent injury.	Never operate generator with guarding or cover plates removed. Avoid wearing loose fitting clothing or jewellery which could be caught by moving parts.

Risk from lifting		
Hazard	What could happen	How to prevent it
Lifting a very heavy object.	Serious injury can result from attempting to lift too heavy an object.	When lifting, always keep the object you are lifting near the vertical axis of your body. DO NOT use you back to lift heavy loads. Both people should crouch down, grab the underside of unit and use your legs to carry the weight. Keep the object as near the centre of your body's gravity as possible. Avoid twisting your bodies when carrying the unit; instead, turn your whole body using your feet.

1. Do not operate in a hazardous location. Such areas include where there is a risk of explosion of petrol fumes, leaking gas or explosive dust.

2. Do not operate in a confined area. Exhaust gases, smoke or fumes could reach dangerous concentrations.

3. The output of this generator is potentially lethal. The generator should not be connected to a fixed electrical installation except by an appropriately licensed person.

4. Protect your generator. This generator is NOT WEATHERPROOF and should not be exposed to direct sunlight, high ambient temperature and damp, wet or high humidity conditions.

5. Do not smoke while refuelling. This is potentially dangerous as it may ignite the fuel and cause an explosion.

6. Take care not to spill fuel. When refuelling the generator ensure that the engine has been switched off. Prevent the spilling of fuel as this may also ignite with the hot engine. Never refuel whilst the engine running.

7. Be careful where you store the generator. Store the generator in a dry area away from inflammable liquids.

8. Keep your distance. The generator emits exhaust fumes. As a safety precaution do not stand close to the unit whilst it is in operation. Ensure bystanders also keep their distance.

9. Never fill fuel tank indoors. Never fill fuel tank when engine is running or hot. Do not smoke when filling fuel tank.

11. Engine speed has been factory set to provide safe operation. Tampering with the engine speed adjustment could result in overheating of attachments and could cause a fire. Never attempt to “speed-up” the engine to obtain more performance. Both the output voltage and frequency will be thrown out of standard by this practice, endangering attachments and the user.

You **MUST** unplug any load from the generator before starting and stopping to prevent permanent damage to any appliances.

Unpacking

Due to modern mass production techniques, it is unlikely that your POWERTEC Generator is faulty or that a part is missing. If you find anything wrong, do not operate the tool until the parts have been replaced or the fault has been rectified. Failure to do so could result in serious personal injury.

Know Your Product

1. Fuel Tank
2. Fuel Tank Cap
3. Fuel Lever Gauge
4. AC Safety Switch
5. AC Sockets
6. Ground (earth) Terminal
7. Volt Meter
8. Oil Filler Cap
9. Oil Drain
10. Low Oil Alert Light
11. Key Start Ignition
12. Fuel Valve
13. Air Filter Cover
14. Choke Lever
15. Recoil Start
16. Spark Plug
17. Fuel Drain
18. Tap Extension Fuel Filter

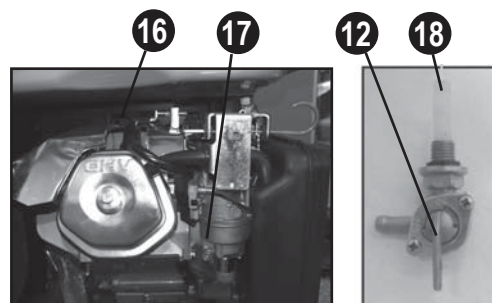
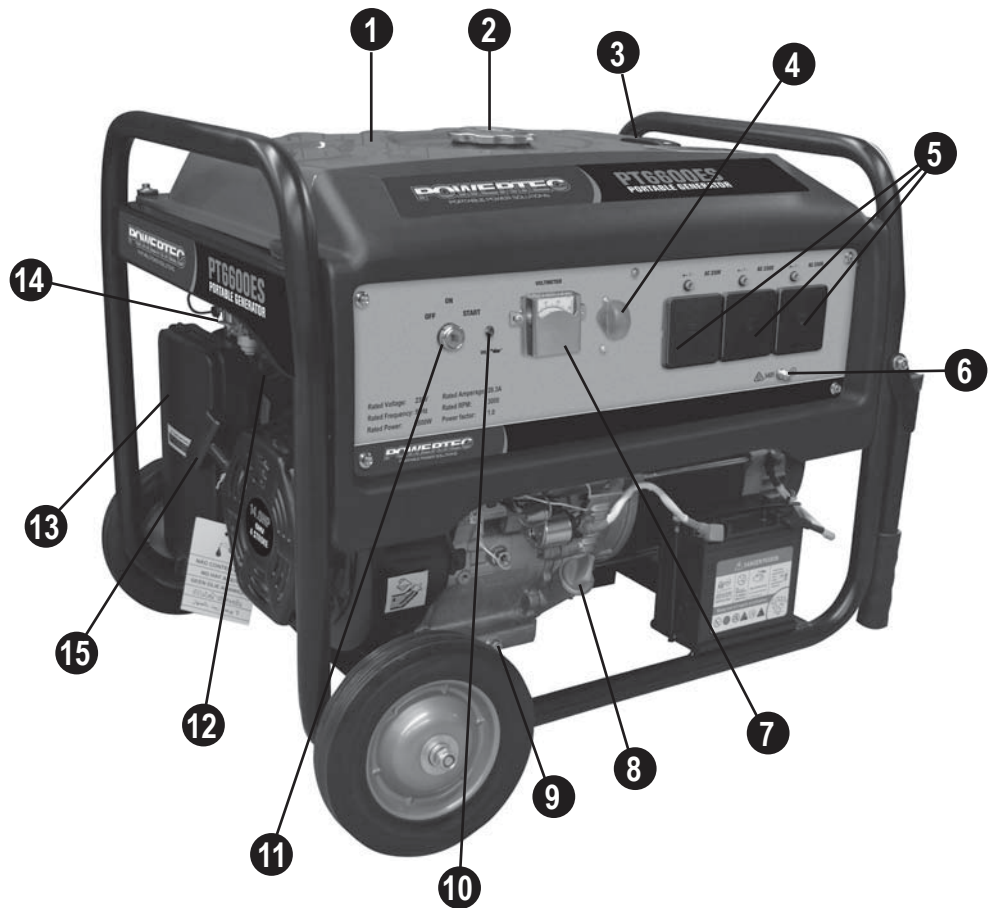

Approximate Wattage Requirements

IMPORTANT: Always check that the combined load of your appliances does not exceed the rated output of your generator. Always select a generator that has more capacity than your load requirements. The small amount extra you may invest to do this will be quickly recovered with the fuel saving and longer service life gained by not having to constantly run your generator at full load.

This chart lists average power requirements. Your particular tool or appliance may require more or less than the listed wattage.

* Where START wattage is the same as RUN wattage, this signifies no additional power is required for starting.

APPLIANCES / TOOLS	APPROX. RUN (W)	APPROX. START (W)	APPLIANCES / TOOLS	APPROX. RUN (W)	APPROX. START (W)
Microwave 750W	750	800	Central Air Conditioner:		
Coffee Maker	1750	1750	10,000 BTU	1500	2200
Electric Clothes Drier	5750	5750	24,000 BTU	3800	5000
Washing Machine	1150	2300	32,000 BTU	5000	6500
Refrigerator	700	2200	Room Air Conditioner:		
Lights	100	100	10,000 BTU	1500	2200
Colour Television	350	350	Circular Saw 7 1/4"	1400	2300
Electric Frypan	1500	1500	Chainsaw 2HP	1100	1100
Dehumidifier	400	400	Portable Air Compressor	1200	2300
Computer - Desktop	700	700	Hand Drill 1/2"	600	600
VCR	50	50	Drill 1/2"	600	900
Dishwasher - Cool Dry	700	1400	Battery Charger 15 amp	500	700
- Hot Dry	1450	2000	Electric Welder 200 amp AC	9000	9000
Toaster - 2 Slice	1250	1250	Jigsaw	300	300
- 4 Slice	1600	1600	Electric Weed Trimmer	500	500
Freezer	2200	2500	Router	1000	1000
Hair Dryer	800-1700	800-1700	Belt Sander	1000	1000
Steam Iron	1800	1800	Table Saw 10"	1750	4250
Garage Door Opener - 1/4 HP	550	1100	Bench Grinder	1400	2450
- 1/3 HP	725	1400	Concrete Mixer 3.5c/f	1900	2500
Radio	200	200	Band Saw	1100	1350
Blender	375	500	Power Drill - Medium	1000	1000
Sump Pump 1/2 HP	1050	2150	- Heavy Duty	1500	1500
Well Pump 1/2 HP	1000	2100	Angle Grinder - 100mm	1000	1000
Household Water Pump	1200	2700	- 230mm	2400	2700

NOTICE: Synchronous generators such as this model may not be suitable to power sensitive electronic equipment such as computers and other equipment with digital control circuitry. Operation of such equipment with this model generator may cause issues and/or permanent damage to the equipment. For powering sensitive electronic equipment, we recommend to use an inverter generator. Please contact your Powertec dealer for further details.

Preparing the Generator

It is important to check the generator before you commence operating the unit.

IMPORTANT: Ensure that the engine has oil. When leaving the factory this generator has NO OIL in the engine.

NOTE: The generator will not start if the generator has no oil.

Checking the Engine Fuel

1. Switch off engine by pressing the engine switch to the 'off' position.
2. If the fuel is low, remove the fuel cap (2) by turning anti-clockwise.
3. Check to ensure the fuel filter screen is inside the fuel filter neck.
4. Pour the unleaded fuel from an approved fuel container into the fuel tank (1). Because fuel expands, DO NOT FILL to the top of the tank.
5. Replace fuel cap (2) and turn clockwise to lock.

WARNING:

- Do not refill fuel tank (1) while engine is running or is hot.
- Check to ensure that the fuel drain (16) has been tightened and that fuel is not leaking.
- Be careful not to admit dust, dirt, water or other foreign objects into the fuel.
- Wipe off spilt fuel thoroughly before starting engine.
- Ensure you DO NOT fuel the generator in close proximity to any open flames.

Checking the Engine Oil

The motor of this generator is not filled with oil when shipped.

Prior to starting the motor ensure the crank case is filled with SAE #30 4 stroke oil (capacity 1100ml).

Damage to the motor is not covered under warranty if the motor is run without oil.

1. Before checking or refilling oil, be sure the generator is put on a stable and level surface, ensuring the engine has been switched OFF.
2. Remove the oil filler cap (8) by rotating the cap anti-clockwise and inspect to see the oil level.
3. If the oil level is below the lower level line, refill with SAE #30 4 stroke oil to the upper level line.

NOTE: Do not screw in the oil filler cap (8) when checking oil level, simply insert and pull the cap straight out.

4. If the oil is contaminated or has discoloured, ensure you change the oil. Refer to the '**Engine Oil Replacement**' section for instructions.

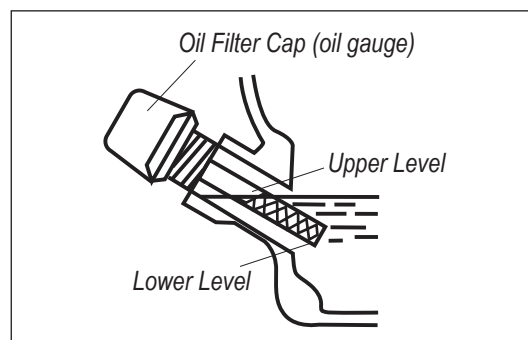

NOTE: This motor is fitted with a low oil sensor. If the oil level is too low, the motor will stop operating or the motor will not start. It is advised to check the oil level each time the generator is used. When the oil level is too low, the motor will stop operating or the motor will not start. It is advised to check the oil level each time the generator is used.

Connecting the Battery

NOTE: Before using the key start function of the generator you must connect the battery to the generator.

1. Secure the battery to the battery tray with the provided battery clamp using the wingnuts (also included).

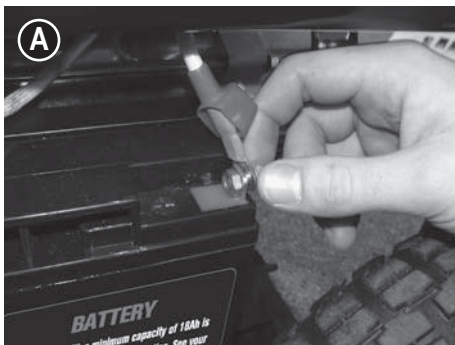

2. Secure the battery leads to the battery terminal with the nut and bolt provided. The red lead connects to the positive (+) terminal and the black lead connects to the negative (-) terminal (Fig. A).



3. Ensure the leads are firmly tightened to the battery terminal (Fig. B).

Starting the Engine with Key Start

WARNING: Before starting the motor, ensure you have filled the crank case to the correct level with oil.

NOTE. The crank case is not filled with oil from the factory.

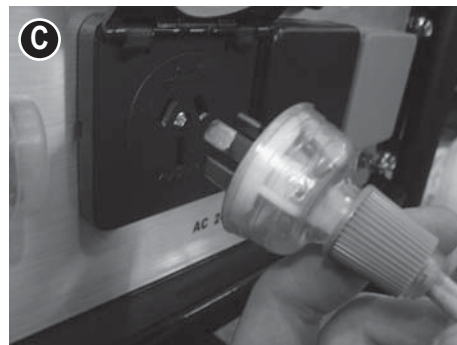

1. Before starting, ensure that no electrical apparatus has been connected to the generator (Fig. C).

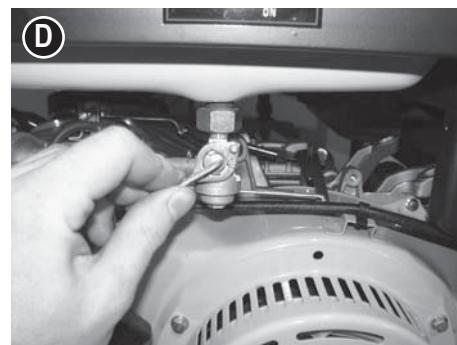

2. Turn the fuel valve (12) anti-clockwise to the 'on' position (Fig. D).



3. Move the choke lever (14) towards the back of the generator (to the left). This is not necessary if the engine is already warm.

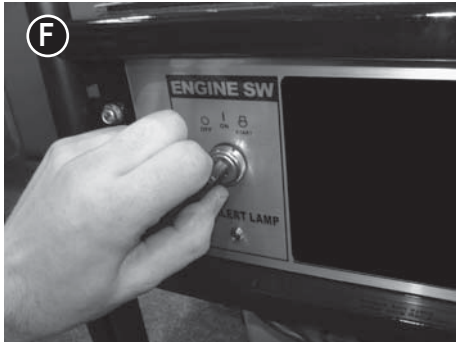

4. Turn the key start ignition (11) clockwise to the 'START' position (Fig. F).

NOTE: When the motor is started for the very first time, it may require a number of attempts to start until the fuel has travelled from the tank to the motor.

5. Once you hear the motor operating, release the key to allow the position to move from 'START' to 'ON' (Fig. F).
6. Push the choke lever (14) back in towards the generator. This position will switch the choke 'off'.

Starting the Engine Manually

NOTE: Follow steps 1 to 3 of the 'Starting the engine with key start' section.

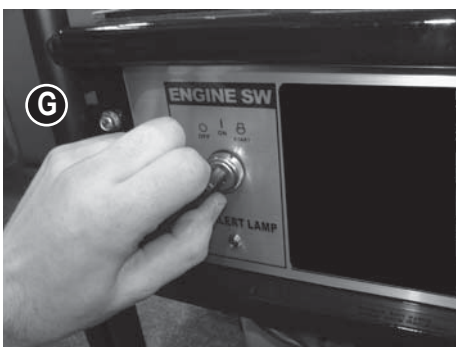

4. Turn the key start ignition (11) clockwise to the 'ON' (Fig. G).
5. Slowly pull the recoil starter until you feel it engage and then pull it briskly.
6. Once you hear the motor operating, push the choke lever (14) back in towards the generator. This position will switch the choke 'off'.

Stopping the Engine

1. Before stopping, ensure that no electrical apparatus is connected to the generator.



2. Turn the key start ignition (11) to the 'OFF' position (Fig. H).
3. Turn the fuel lever clockwise to the 'off' position.

Connecting Apparatus to the Generator

1. Start the engine. Allow the engine to run for a couple of minutes to warm up prior to connecting any apparatus to the generator.
2. For AC current, ensure the AC safety switch (4) is turned "OFF" first, then plug the power cord into one of the AC output sockets (Fig. I).

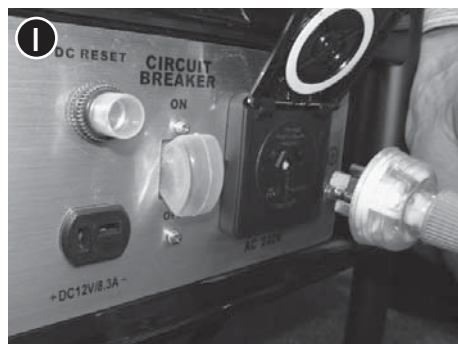

3. Switch the AC safety switch (4) to the "ON" position.

CAUTION:

- Ensure the electric apparatus is turned off before plugging in.
- Check to ensure that the total load is within the generator rated output.

WARNING: Prior to connecting any appliance to the generator, check the rating label of the appliance. The generator is rated at 6500W so if the appliance being connected is higher than 6500W, the protective cut out on the generator may operate to prevent over load damage to the generator. The generator will withstand short operation and loads up to 7000W or the generator may stop if loads in excess of 6500W are applied for more than a short period of time.

NOTE: Motorised products will require more energy upon start up and products which are rated above 30% of the peak power output of the generator. It should also be very clearly understood that output voltage fluctuations will occur when various loads are connected and disconnected. **It is NOT recommended to connect any electronic equipment to the generator without a voltage or surge protector.**

Computers, televisions, and stereo equipment can be very sensitive to the input supply and could be damaged if protective equipment is not used in conjunction with this generator. This also includes caravans where electronic equipment is incorporated as part of the wiring.

AC Safety Switch

This generator has been equipped with an AC safety switch (4), designed to protect people against an electric shock.

Safety Switch Tripping

If the safety switch (4) has tripped and cuts off the power, it may be due to substantial overloading. Marginal overloading may not switch off the safety switch (4), but it will shorten the service life of the generator.

Be sure that all appliances are in good working order before connecting them to the generator. If an appliance begins to operate abnormally, becomes sluggish, or stops suddenly, turn "OFF" both the AC safety switch (4) and the generator engine switch (11) immediately. Then disconnect the appliance and examine it for signs of malfunction.

Resetting the safety switch (4) should restore the power and should be conducted as follows:

1. Unplug all electrical apparatus from the generator.
2. Let the safety switch (4) cool down.
3. Lift the safety switch (4) up to the "ON" position.
4. Commence to start your generator accordingly.
5. When reconnecting appliances, reduce the load to that which previously overloaded the generator.

If the safety switch (4) does not reset due to a faulty electrical appliance or wiring, switch off and unplug the appliance which may be faulty. Any faulty electrical appliances will need to be repaired by a suitably qualified person. If the safety switch does not reset after unplugging the appliance, call a licensed electrician to find the fault.

Generator Maintenance

Periodic maintenance						
Item	Remarks	Pre-operation check (daily)	Initial 1 months or 20Hr	Every 3 months or 50Hr	Every 6 months or 100Hr	Every 12 months or 300Hr
Spark plug	Check condition, adjust gap and clean. Replace if necessary.			.		
Engine oil	Check oil level.	.				
	Replace.		.		.	
Air filter	Clean. Replace if necessary.			.		
Fuel filter	Clean the tap extension filter. Replace if necessary.				.	
Valve clearance	Check and adjust when engine is cold.					.
Fuel line	Check fuel hose for crack or damage. Replace if necessary.	.				
Exhaust system	Check for leakage. Retighten or replace gasket if necessary.	.				
	Check muffler screen. Clean/replace if necessary.				.	
Carburetor	Check choke operation.	.				
Starting system	Check recoil starter operation.	.				
Decarbonisation	More frequently if necessary.					.
Fittings/ fasteners	Check all fittings and fasteners correct if necessary.	.			.	

Regular maintenance is most important for the best performance and safe operation.

Your generator should be kept clean and dry at all times. The generator should not be stored or operated in environments that includes excessive moisture, dust or any corrosive vapours. If these substances are on the generator, clean with a cloth or soft bristle brush. Do not use a garden hose or anything with water pressure to clean the generator. Water may enter the cooling air slots and could possibly damage the rotor, stator and the internal windings of the generator head.

Storage

If you are going to store your generator for more than 30 days, use the following information as a guide to prepare the generator for storage.

WARNING: Never store generator with fuel in the tank indoors or in enclosed, poorly ventilated areas, where fumes can reach an open flame, spark or pilot light as on a furnace, water heater, clothes dryer or other gas appliances.

Always drain the generator, tank and fuel system by opening the small drain valve (15) in the lower section of the carburetor bowl before storing.

Spark Plugs

1. Remove spark plug (15) from the generator with a spark plug spanner socket.
2. Remove carbon deposits using a wire brush.
3. Check for discoloration on the top of the spark plug. The standard colour should be a tan colour.
4. Check the spark plug gap. The acceptable gap should be between 0.7 - 0.8mm.

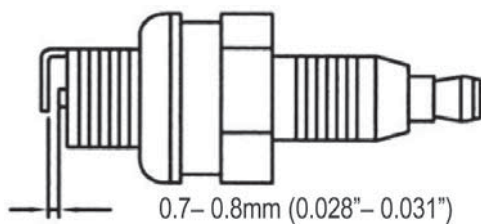

5. The recommended sparkplugs are as follows:

BPR6ES (NGK)	RN9Y (Champion)
W20EPR-U (Denso)	WR6DC (Bosch)

Engine Oil Replacement

1. Place the generator on a level surface and warm up the engine for several minutes. Then stop the engine.
2. Remove oil filler cap (8).
3. Place an oil pan under the generator and commence removing the oil drain cock (9) so that the oil can be completely drained.
4. Check the oil drain cock (9), gasket, oil filler cap (8) and O-ring. If damaged, have these replaced.
5. Reinstall the oil drain cock (9).
6. Add engine oil to the upper level. Recommended 4 stroke engine oil is SAE #30. Refer to the "Checking the Engine Oil" section in this instruction manual.

CAUTION: Check that no foreign material, debris, dust enters the crankcase.

Air Filter

It is very important to maintain an air filter in proper condition. Damage to the generator may arise if the filter has:

- Improperly been serviced.
- Dirt and other foreign elements adhering to the filter due to improper installation and engine wear.

ALWAYS keep the filter clean at all times.

1. Remove the air filter cover (13) on the side of the generator by releasing the metal clip.



IMPORTANT: Never run the engine without the air filter element in place!

2. Remove the air filter.



3. Wash the air filter in solvent or kerosene and allow to dry.
4. Lubricate the filter using motor oil (SAE #30).
5. Thoroughly squeeze the filter removing excess oil.
6. Replace air filter back into the engine.
7. Secure the cover back onto the side panel of the generator.

Petrol Tank Filter

1. Stop the engine.
2. Turn fuel valve (12) to OFF position.
3. Petrol tank filter is located directly under petrol cap. This protects impurities entering fuel tank during refuelling.

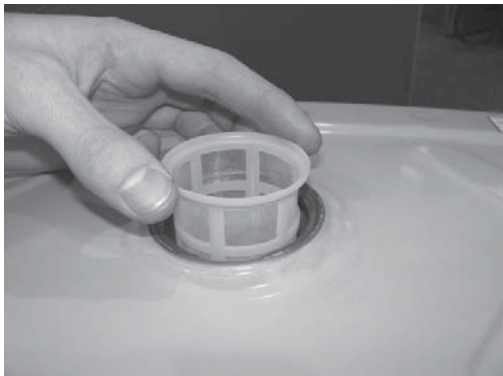

4. Remove the filter and wash thoroughly in a solvent.
5. Re-assemble.

Tap Extension Fuel Filter

A small fuel filter has been fitted to the inlet side of the fuel valve (12), inside the tank. This tap extension fuel filter (17) prevents any dirt in the fuel from entering the fuel system. The following procedure explains the removal of this filter in order to replace or clean it.

NOTE: The following procedure should be performed in a well ventilated area, with no naked flames, sparks, or cigarettes. Safety glasses should also be worn and engine switch (11) set to the OFF position.

1. Completely empty the tank of fuel. Ensure the fuel valve (12) is in the OFF position.

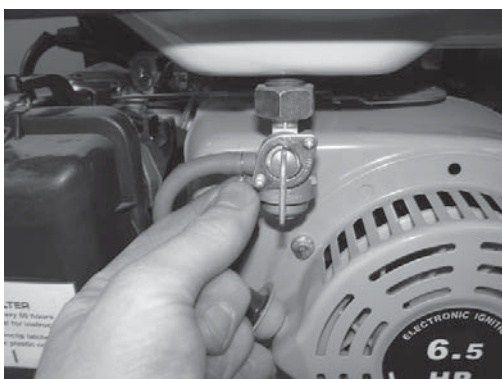

16.

2. Compress the two wire arms of the hose clamp on the outlet hose at the fuel valve (12) and slide the clamp back from the end of the hose by approx. 25mm. Slide the fuel hose off the outlet of the fuel valve (12).
3. Loosen the lock nut locking the fuel valve (12) on to the tank. Unscrew the tap from the tank and withdraw the tap from the tank. Be careful not to lose the small seal on the thread of the tap.

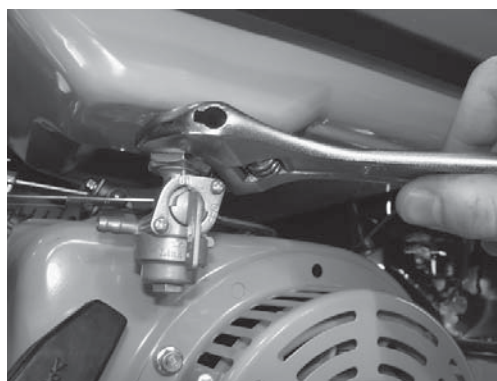

4. Unscrew the tap extension fuel filter (17).

NOTE: This filter can be cleaned in petrol to remove any build-up of dirt on the outside of the filter, or the filter can be replaced. Do not operate the generator without this filter in place. To replace the filter after cleaning, or with a new filter, simply screw the filter into the inlet side of the tap.

5. Ensuring the small seal is fitted to tap, thread the tap back into the tank by a FULL 3 - 4 turns. Orientate tap so outlet of tap is towards rear of tank, and tap control is to right hand side of tank. Holding tap firm, tighten lock nut, ensuring seal is clamped between lock nut and tank.

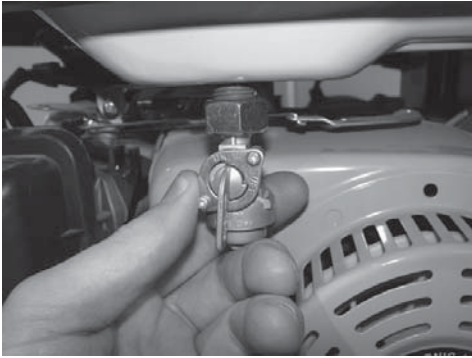

6. Refit fuel hose to outlet of the tap and with wire arms compressed, slide hose clamp up onto connection of hose and tap.
7. Refill tank with fuel. Ensure there are no leaks between tap and tank. With fuel tap turned on, ensure there are no leaks where fuel hose is fitted to outlet of tap.

Repairs

Only an authorised service centre should repair generator. See contact details for service under the warranty / service section on the following page.

Cleaning

1. Keep machine clean. Outside of machine can be cleaned using a damp soft cloth with mild detergent if required. Never use water to clean generator as it may cause damage to internal parts.
2. Some maintenance products and solvents may damage plastic parts; these include products containing benzene, trichloroethylene, chloride & ammonia.
3. Use a vacuum to clean air inlet and outlet louvres of alternator.
4. Take special care to keep ventilation inlets/outlets free from obstruction; cleaning with soft brush followed by a compressed air jet to ensure acceptable internal cleanliness.
5. Wear eye protection when carrying out cleaning.

Troubleshooting

Trouble	Possible Cause	Suggested Remedy
Engine will not start or will not keep running	1. Low on fuel	1. Add fuel / oil mix
	2. Low on oil	2. Check oil level and top up
	3. Faulty spark plug	3. Replace spark plug
	4. Choke in wrong position	4. Adjust choke accordingly
	5. Fuel tap in closed position	5. Open fuel tap
	6. Unit loaded during start-up	6. Remove load from unit
	7. Spark plug wire loose	7. Attach wire to spark plug
	8. Dirty fuel filters	8. Clean filters as per instructions
No electrical output	1. Faulty receptacle	1. Have service centre replace receptacle
	2. Circuit breaker kicked out	2. Depress and reset
	3. Defective AVR	3. Have service centre replace AVR
	4. Faulty power cord	4. Replace cord
Repeated circuit breaker tripping	1. Overload	1. Reduce load
	2. Faulty cords or equipment	2. Check for damaged, bare or frayed wires on equipment. Replace.
	3. Circuit breaker is faulty	3. Have service centre replace circuit breaker
Generator overheating	1. Generator overloaded	1. Reduce load
	2. Insufficient ventilation	2. Move to adequate supply of fresh air

Warranty

As part of an on-going commitment to excellence in product support, Euroquip offers a comprehensive product warranty program.

1. THIS WARRANTY:

The benefits provided to the consumer in this warranty are in addition to other rights and remedies of a consumer under the New Zealand Consumer Guarantees Act 1993 and any other laws in relation to the products to which this warranty relates. This warranty:

- Covers the product against faulty materials or workmanship; and
- Covers the replacement of parts, the repair labour used, a refund of the price of the product or replacement of the machine, or other compensation for the remainder of the warranty period.

This product warranty is only applicable to the original purchaser of the machine and only purchases made from Euroquip Authorized Retailers.

2) WARRANTY PERIODS:

Domestic/Commercial: 12 Months

Or

1000 hours of operation – whichever occurs first.

Domestic Warranty applies to domestic use of the product: Personal, residential, or household use only. Commercial Warranty applies to commercial or business use of the product: All uses other than domestic use, including use for income-producing (including farming) or rental purposes.

*These Powertec Warranty periods are for products that are:

- Serviced by a Powertec Dealer in accordance with the Powertec service schedule, using genuine parts and the correct grade of oil (proof required)
- Meeting all other warranty requirements

NOTE: These warranty conditions apply to New Zealand only.

Euroquip warrants each new Powertec machine free from defect in material and workmanship under normal use and routine servicing, for the warranty periods specified. Conditional to the limitations and exclusions list below. The warranty period begins when the product is purchased by the end user. Warranty is not transferrable and is only claimable by the original purchaser.

Proof of purchase documentation with product serial number must be provided. If it has been lost and Euroquip does not have a record of the purchaser's details, the warranty period shall be calculated from the appropriate dealer wholesale sale date.

The purchaser must keep a record of all service and maintenance history as proof of servicing history. This may be requested when assessing any future warranty claims. The decision that an issue with a product qualifies as a warranty claim is made at the sole jurisdiction of Euroquip.

No costs incurred will be considered under warranty if repairs or maintenance are carried out by any party other than a Euroquip Approved Service Agent, unless with prior consent in writing from Euroquip.

It is the full responsibility of the purchaser to deliver the product under warranty to the nearest relevant service agent or product reseller. Warranty does not cover transportation costs including call outs, mileage and freight costs.

Customers are responsible for the care and cleaning of their product prior to sending it to our service centre. Any product being sent us must be thoroughly cleaned. Depending on what the product has come into contact with, it could pose an Occupational/ Work Health and Safety risk for our staff and or/service agents to inspect, repair or service a product that has come into contact with a hazardous substance. If we are asked to inspect, repair or service a product that has come into contact with a hazardous substance such as chemicals, asbestos or silica dust, we may not be able to inspect, service or repair the product. If this is the case, we will inform the purchaser and the product will be returned.

If a product is repaired under warranty, parts and labour required for the repair will be supplied at no charge. All defective parts replaced under warranty become property of Euroquip. Consumable items such as, but not limited to, oils, coolants, filter and spark plugs shall be the responsibility of the owner. Warranty assessment and repair will be scheduled and executed according to the normal work flow at the service location and depending on the availability of suitable replacement parts.

This warranty policy is an additional benefit and does not supersede the legal rights of any customer, reseller or service agent.

Should any issue be found to be a combination of a warranty failure and a non-warranty issue such as incorrect charging techniques, the repair cost component to rectify and repair the non-warranty failure is the **customer's** full responsibility.

3) EXCLUSIONS:

- Warranty does not cover parts that are subject to wear and tear from usage and/or damage which results from neglect of periodic maintenance.
- Evidence must be provided that the product has been maintained and serviced suitably for a claim to be considered under warranty.
- Batteries supplied with your product are warranted against defect for 3 months and does not include lack of charge due to non-use. Consumable items such as, but not limited to, oils, coolants, filters, spark plugs and batteries shall be the responsibility of the purchaser.
- Failure caused by incorrect operation of the product as specified in the manual either intentionally or by error.
- Lack of proper care and maintenance of the product.
- Any damage which results from unavoidable natural disasters, fire, collision, theft, etc.
- Any normal wear or deterioration, such as that of sliding or rotating parts caused under normal operating conditions.
- Any damage that results from misuse or use beyond the imitations of the products intended purpose (such as overloading or use under abnormal conditions).
- External circumstances such as product deterioration or corrosion due to environmental conditions like heat, cold, salt spray, sand or due to the passage of time
- Normal phenomena such as noise, vibration or oil seepage which are considered by Euroquip as not affecting the quality, function or performance of the product.
- Any damage due to improper storage or transport.
- Consumable replacement items: Spark plugs, contact points, shear pins, fuel strainers, oil filter elements, air cleaner elements, brake shoes or pads, clutch components, fuses, motor brushes, gaskets, tube or hoses, belts, cutting blades, light bulbs, serviceable bearings. Petroleum and others fluids: Oil, grease, battery electrolyte, and radiator coolant. Other items specified by Euroquip.
- Periodical maintenance items such as cleaning, inspection and adjustments.
- Contaminated fuel
- Modifications or installations of other products to the product
- Damage that results from the use of non-genuine parts, lubricant or fluid not approved by Euroquip
- Any repair and/or adjustment to correct improper or poor quality work previously performed.
- Attempted repair/ service by a party other than an Approved Service Agent, or any repair undertaken prior to approval of warranty by Euroquip is not covered under warranty.
- Warranty does not cover pre delivery service and adjustment, or failure that may occur as a result of lack of/ incorrect pre delivery service and adjustment. Warranty does not cover any incidental, indirect or consequential loss, damage, personal injury, or expense that may result from any defect, failure, malfunction, or misuse of a product.
- Any product that is found to have come into contact with hazardous substances such as chemicals, asbestos or silica dust and NOT been industrially cleaned prior to servicing.

4) HOW TO CLAIM WARRANTY:

In the event you are faced with a manufacturing fault with your Powertec product, you can claim a repair or part replacement under warranty if the following conditions are fulfilled:

- The problem is related to production quality or specifications of the machine
- The machine is within the warranty period outlined in schedule
- The issue does not fall within the warranty exclusions listed

If the criteria above is met, and you would like to request a warranty, then please go online to <https://www.euroquip.co.nz/Service-Request-End-User> and log your warranty claim.



Congratulations on your new POWERTEC product. We are proud to have you as our customer and will strive to provide you with the best service and reliability in the industry. This product is backed by our extensive warranty and world-wide service network. To locate your nearest distributor or service agency call **0800 387 678**, or email us at **info@euroquip.co.nz**.